

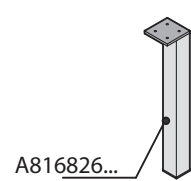

## COLUMN

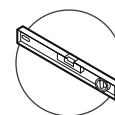
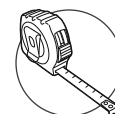
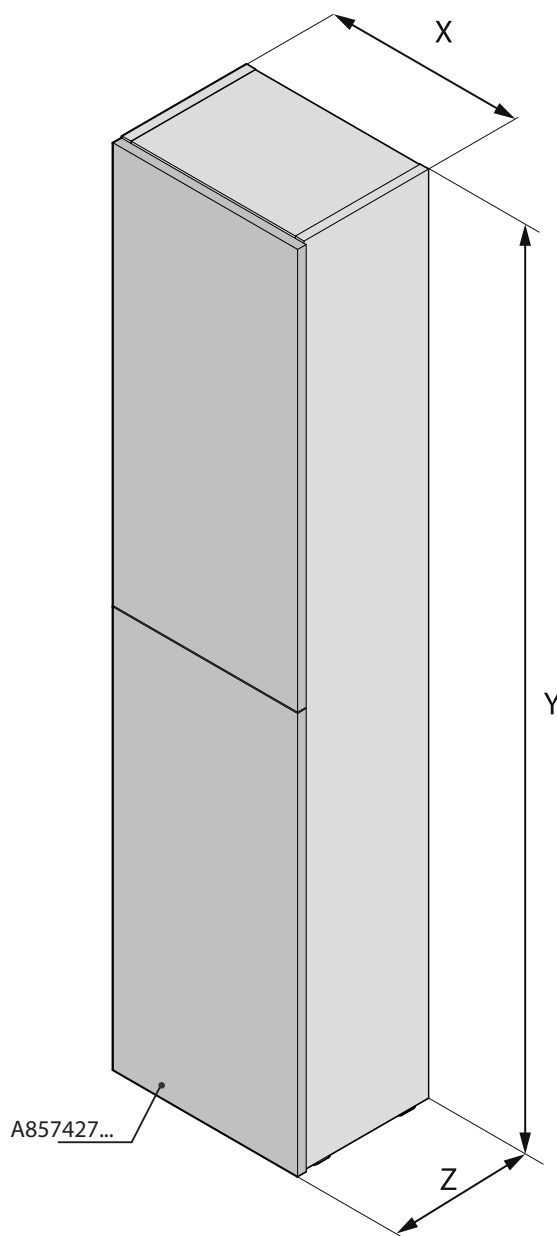

	mm		
	X	Y	Z
A857427...	345	1504	250

	mm		
	X	Y	Z
A816826...	35	335	35

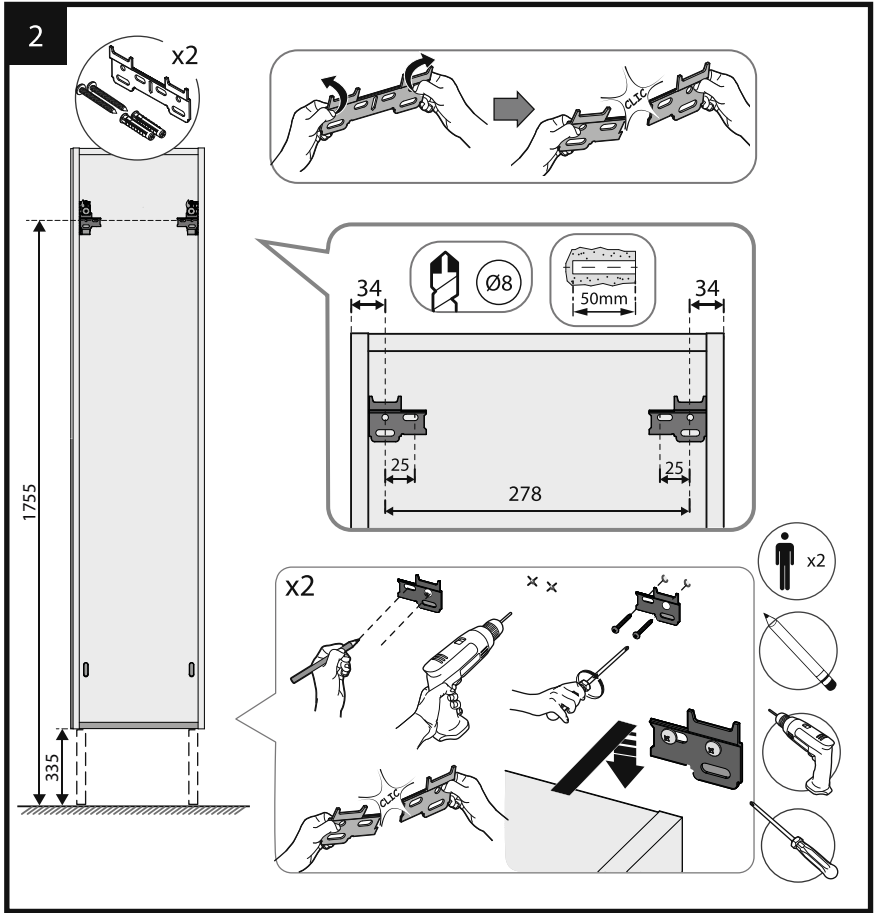
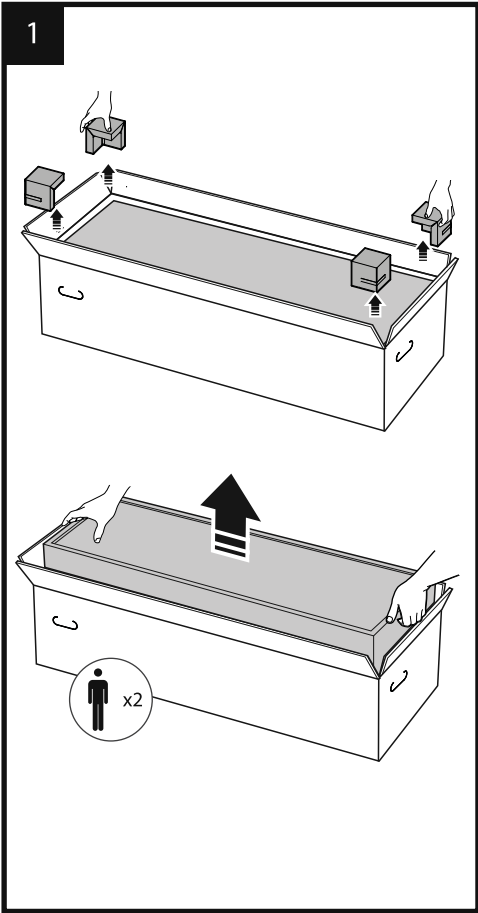

**OPTIONAL**

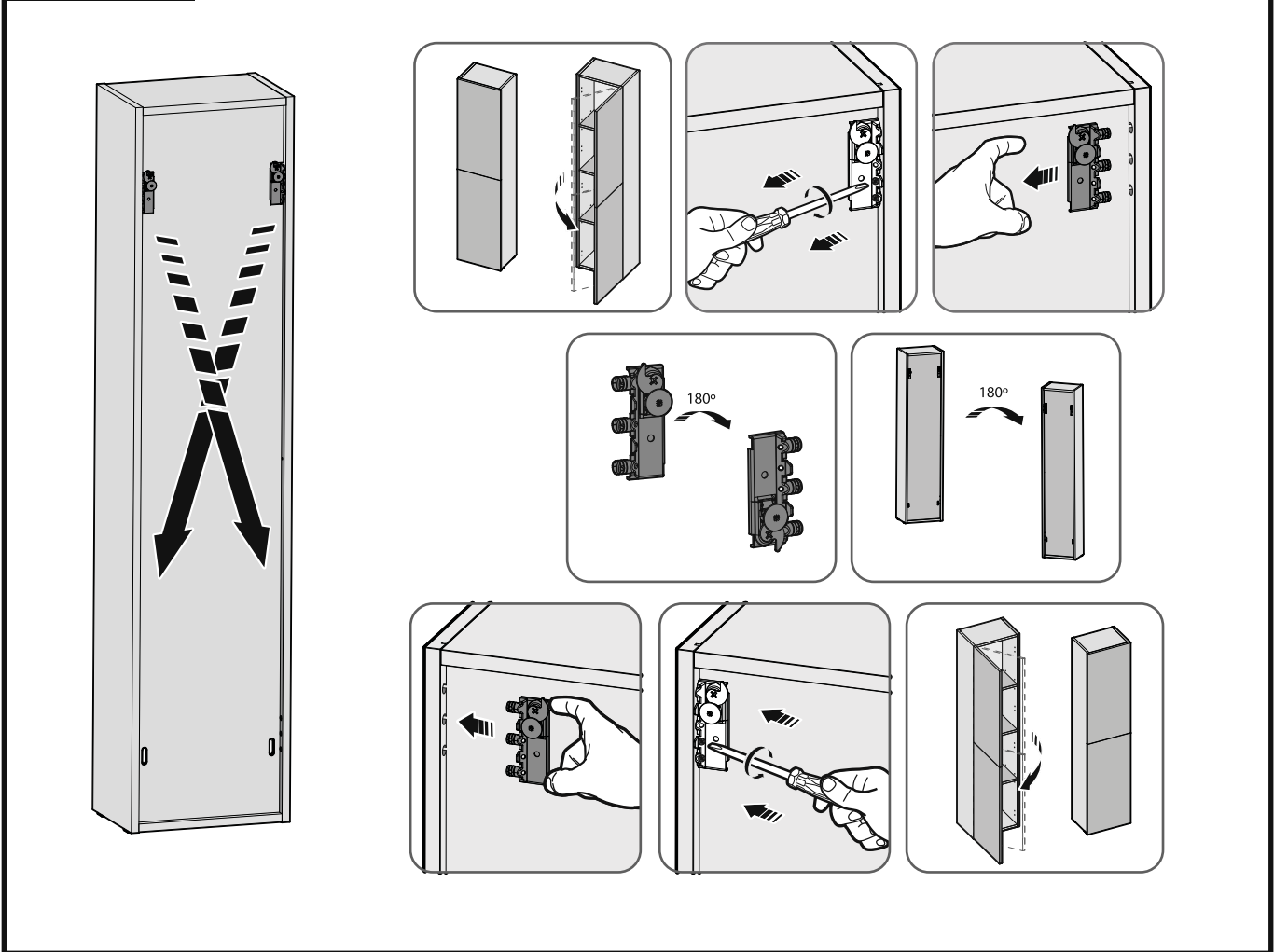

OPTIONAL

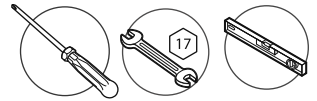
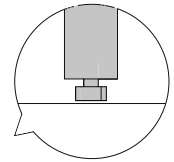
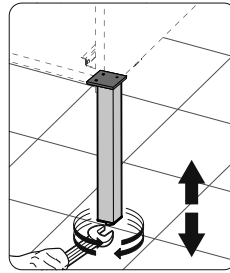
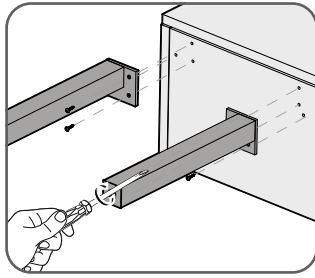
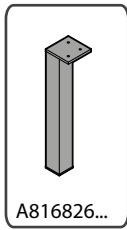
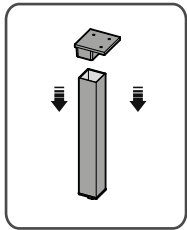

3

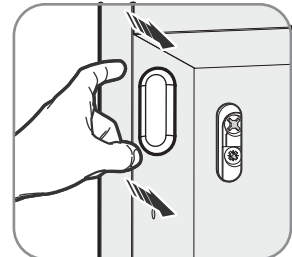
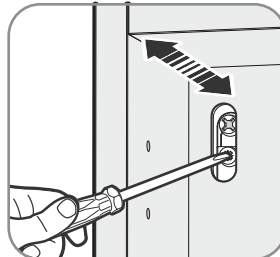
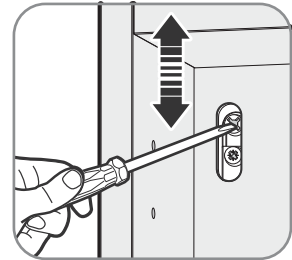
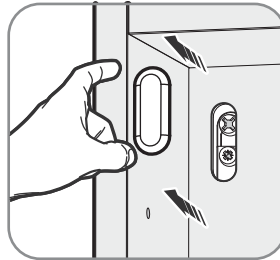
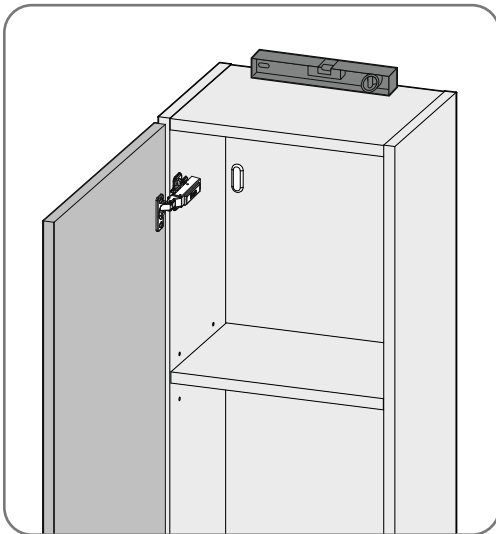

4

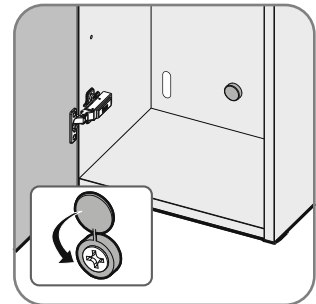
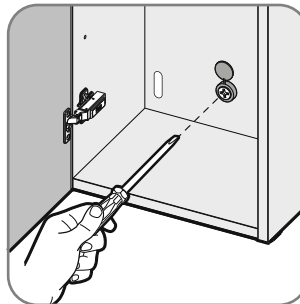
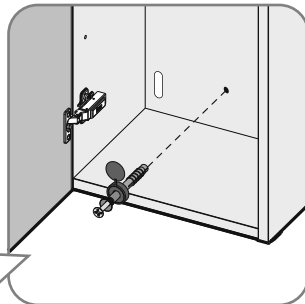
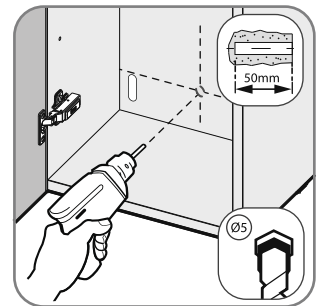
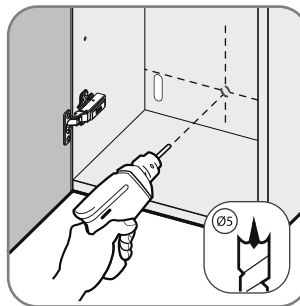
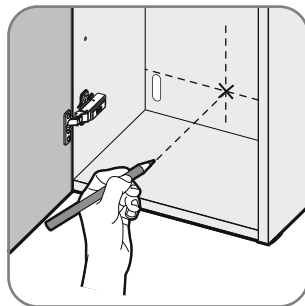
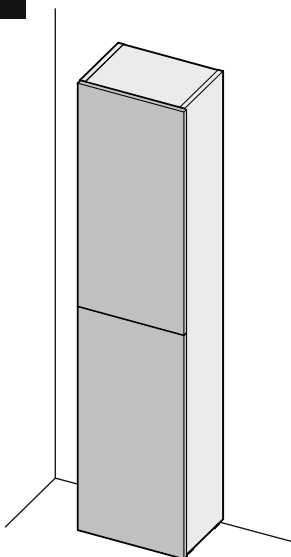

OPTIONAL

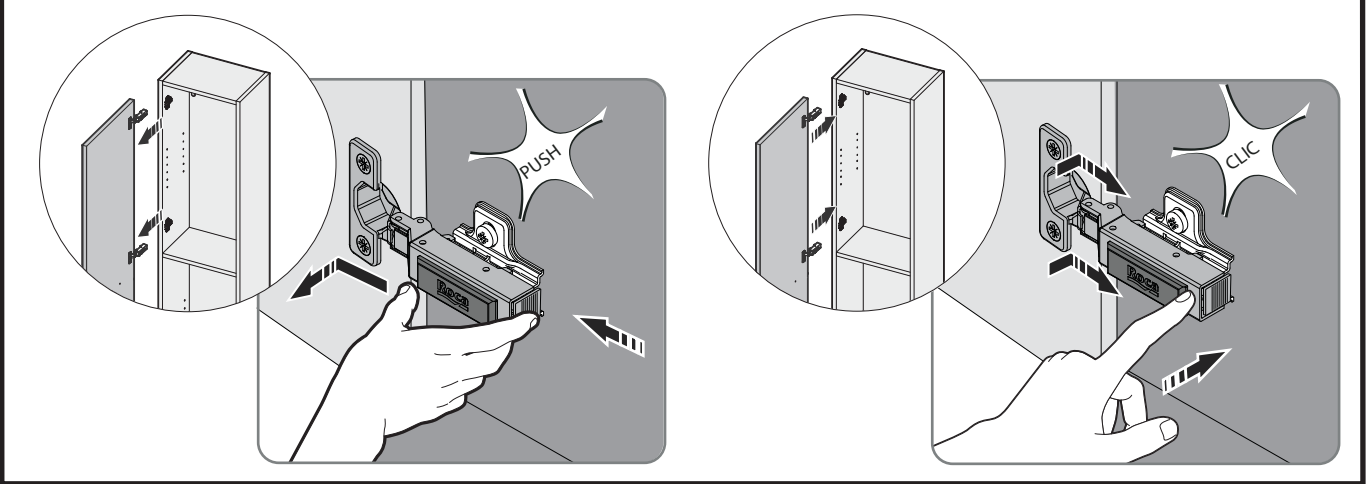

5

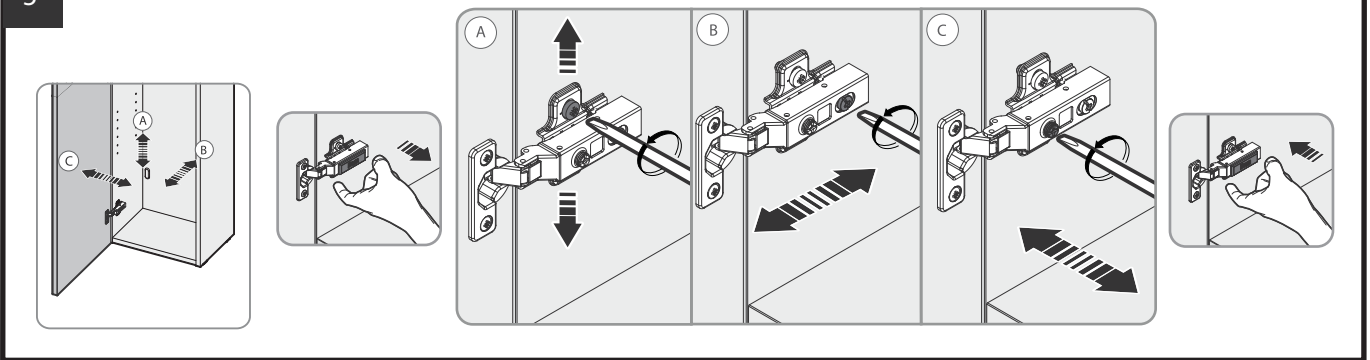

6

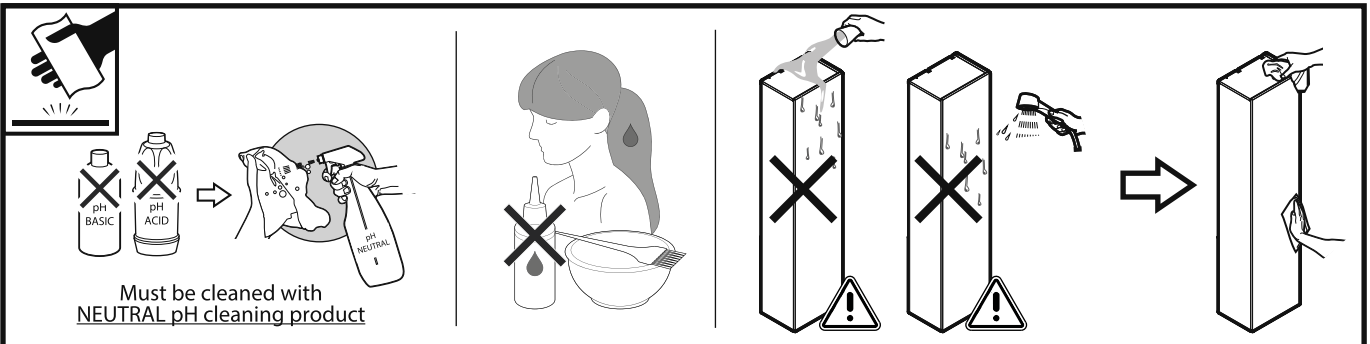
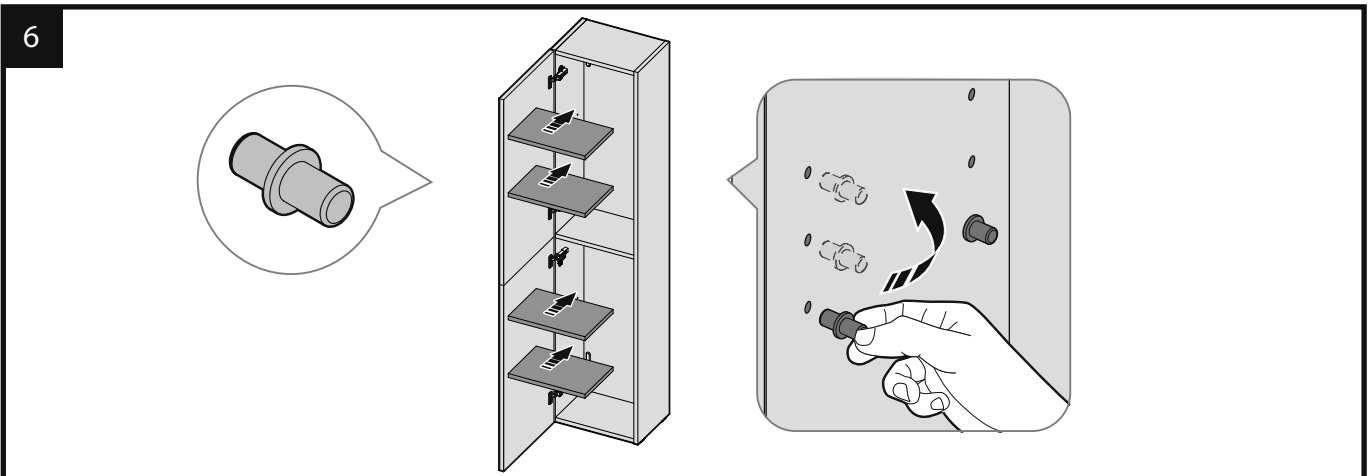

DIN A3

Q40600234G-e



Roca Sanitario, S.A.  
Avda. Diagonal, 513  
08029 Barcelona  
SPAIN  
www.roca.com

933 LÍNEA DE ATENCIÓN  
661 AL CONSUMIDOR  
266 ESPAÑA  
SERVICIO TÉCNICO  
ESPAÑA



productsupport.rs@roca.net  
soporteproducto.rs@roca.net